



# TOPVIEW® CAMERA SYSTEM HCE-C500

EN

- OWNER'S MANUAL  
Please read before using this equipment.

---

**ALPINE ELECTRONICS MARKETING, INC.**

1-1-8 Nishi Gotanda,  
Shinagawa-ku,  
Tokyo 141-0031, Japan  
Phone 03-5496-8231

**ALPINE ELECTRONICS OF AMERICA, INC.**

19145 Gramercy Place, Torrance,  
California 90501, U.S.A.  
Phone 1-800-ALPINE-1 (1-800-257-4631)

**ALPINE ELECTRONICS OF CANADA, INC.**

777 Supertest Road, Toronto,  
Ontario M3J 2M9, Canada  
Phone 1-800-ALPINE-1 (1-800-257-4631)

**ALPINE ELECTRONICS OF AUSTRALIA PTY. LTD.**

161-165 Princes Highway, Hallam  
Victoria 3803, Australia  
Phone 03-8787-1200

**ALPINE ELECTRONICS GmbH**

Wilhelm-Wagenfeld-Str. 1-3,  
80807 München, Germany  
Phone 089-32 42 640

**ALPINE ELECTRONICS OF U.K. LTD.**

Alpine House  
Fletchamstead Highway,  
Coventry CV4 9TW, U.K.  
Phone 0870-33 33 763

**ALPINE ELECTRONICS FRANCE S.A.R.L.**

(RCS PONTOISE B 338 101 280)  
98, Rue de la Belle Etoile, Z.I. Paris Nord II,  
B.P. 50016, 95945 Roissy Charles de Gaulle  
Cedex, France  
Phone 01-48638989

**ALPINE ITALIA S.p.A.**

Viale C. Colombo 8, 20090 Trezzano  
Sul Naviglio (MI), Italy  
Phone 02-484781

**ALPINE ELECTRONICS DE ESPAÑA, S.A.**

Portal de Gamarra 36, Pabellón, 32  
01013 Vitoria (Alava)-APDO 133, Spain  
Phone 945-283588

**ALPINE ELECTRONICS (BENELUX) GmbH**

Leuvensesteenweg 510-B6,  
1930 Zaventem, Belgium  
Phone 02-725-13 15



# Contents

## Operating Instructions

### WARNING

WARNING .....	2
CAUTION .....	3
NOTICE.....	3

### Feature

About the TOPVIEW® CAMERA SYSTEM.....	4
Example of Camera Installation.....	4
Example of Camera Image.....	4

### Camera Image

Image Patterns and Distance	
Guidelines.....	6
How to Interpret a Camera Image.....	6
About the Front Camera Image and Camera Guide .....	7
About the Rear Camera Image and Camera Guide .....	8
Error Between the Display and Actual Road Surface.....	10
About Calibration .....	12
About the Image Range .....	12

### Camera Operation

Displaying the Camera Image .....	14
Displaying the Camera Image by Pressing the PDC button .....	14
Displaying the Camera Image using the iDrive Controller.....	15
Displaying the rear view image while the car is in reverse.....	15
Switching Image Patterns .....	16

### Installation and Connections

Check Accessory Parts.....	17
Connections .....	18
System Example .....	19

### Information

Specifications .....	20
In Case of Difficulty .....	20

---

---

# Operating Instructions

## WARNING



## WARNING

This symbol means important instructions. Failure to heed them can result in serious injury or death.

**WHEN USING A CAMERA SYSTEM, THE DRIVER MUST VISUALLY CHECK ACTUAL CONDITIONS AROUND THE VEHICLE. MAKE SURE THERE ARE NO PERSONS OR ANIMALS IN THE AREA IN WHICH YOU ARE MANEUVERING OTHERWISE YOU COULD INJURE THEM.**

A camera assists the driver by sending images to the screen showing conditions in view of the camera. The camera uses a wide-angle lens. Therefore, there is a difference in distance perspective between what is normally seen and what appears on the screen. Also, the images shown by the rear camera are reversed, so as to appear the same as what is seen through the rearview mirror.

The camera may not perform to full capability due to variables such as:

- weather conditions such as hard rain, snow, fog or mud
- extremely high or low temperatures near camera
- slope of vehicle and/or roadway
- direct exposure to very bright light such as headlamp or bright sunlight
- moving from very dark to very bright light and vice versa such as in parking garages or tunnels
- extremely low light areas
- walls or objects that are located diagonally in relation to the camera
- retracted mirrors that change camera viewing angle
- open doors or trunks
- changes to height of vehicle due to loading capacity or hydraulic suspensions
- obstacles located at the corner of the vehicle

---

### DO NOT DISASSEMBLE OR ALTER.

Doing so may result in an accident, fire or electric shock.

---

### KEEP SMALL OBJECTS SUCH AS BOLTS OR SCREWS OUT OF THE REACH OF CHILDREN.

Swallowing them may result in serious injury. If swallowed, consult a physician immediately.

---

### USE THE CORRECT AMPERE RATING WHEN REPLACING FUSES.

Failure to do so may result in fire or electric shock.

---

### USE ONLY IN CARS WITH A 12 VOLT NEGATIVE GROUND.

(Check with your dealer if you are not sure.) Failure to do so may result in fire, etc.

---

### BEFORE WIRING, DISCONNECT THE CABLE FROM THE NEGATIVE BATTERY TERMINAL.

Failure to do so may result in electric shock or injury due to electrical shorts.

---

### DO NOT USE BOLTS OR NUTS IN THE BRAKE OR STEERING SYSTEMS TO MAKE GROUND CONNECTIONS.

Bolts or nuts used for the brake or steering systems (or any other safety-related system), or tanks should NEVER be used for installations or ground connections. Using such parts could disable control of the vehicle and cause fire etc.

---

### DO NOT DAMAGE PIPE OR WIRING WHEN DRILLING HOLES.

When drilling holes in the chassis for installation, take precautions so as not to contact, damage or obstruct pipes, fuel lines, tanks or electrical wiring. Failure to take such precautions may result in fire.

---

### MINIMIZE DISPLAY VIEWING WHILE DRIVING.

Viewing the display may distract the driver from looking ahead of the vehicle and cause an accident.

---

### DO NOT SPLICE INTO ELECTRICAL CABLES.

Never cut away cable insulation to supply power to other equipment. Doing so will exceed the current carrying capacity of the wire and result in fire or electric shock.

---

### DO NOT INSTALL IN LOCATIONS WHICH MIGHT HINDER VEHICLE OPERATION, SUCH AS THE STEERING WHEEL OR GEAR LEVER.

Doing so may obstruct forward vision or hamper movement etc. and results in serious accident.

---

### DO NOT ALLOW CABLES TO BECOME ENTANGLED IN SURROUNDING OBJECTS.

Arrange wiring and cables in compliance with the manual to prevent obstructions when driving. Cables or wiring that obstruct or hang up on places such as the steering wheel, gear lever, brake pedals, etc. can be extremely hazardous.

---

### DO NOT ROUTE ELECTRICAL CABLES NEAR HOT OR MOVING PARTS

Route the cables and wiring away from hot or moving parts, and fix them securely to avoid heat/mechanical damage to the cable insulation, which may result in shortcircuit, fire or electric shock.

---

### MAKE THE CORRECT CONNECTIONS.

When making connections to the vehicle's electrical system, be aware of the factory installed components (e.g. on-board computer). Do not tap into these leads to provide power for this unit. When connecting the device to the fuse box, make sure the fuse for the intended circuit of the device has the appropriate amperage. Failure to do so may result in fire or damage to the unit and/or the vehicle. When in doubt, consult your Alpine dealer.

---

### USE THIS PRODUCT FOR MOBILE 12 VOLT APPLICATIONS.

Use for other than its designed application may result in fire, electric shock or other injury.

---

### CHECK THAT THE CAMERA MOUNTINGS IS ATTACHED SECURELY, AND THAT THE SCREWS ARE TIGHT BEFORE DRIVING.

Failure to do so may result in an accident.

---

### WHEN INSTALLING OR CHECKING A CAMERA, DO SO AFTER PARKING THE CAR IN A LEVEL, SAFE PLACE, TURNING OFF THE ENGINE, AND APPLYING THE HAND BRAKE.

Failure to do so may result in an accident.

---

**WHEN USING A DRILL TO MAKE A HOLE, TAKE PRECAUTIONS SUCH AS WEARING GOGGLES SO FRAGMENTS DO NOT GET INTO THE EYES.**

Failure to do so may result in injury.



## **CAUTION**

**This symbol means important instructions. Failure to heed them can result in injury or material property damage.**

---

**HAVE THE WIRING AND INSTALLATION DONE BY EXPERTS.**

The wiring and installation of this unit requires special technical skill and experience. To ensure safety, always contact the dealer where you purchased this product to have the work done.

---

**ARRANGE THE WIRING SO IT IS NOT CRIMPED OR PINCHED BY A SHARP METAL EDGE.**

Route the cables and wiring away from moving parts (like the seat rails) or sharp or pointed edges. This will prevent crimping and damage to the wiring.

---

**USE SPECIFIED ACCESSORY PARTS AND INSTALL THEM SECURELY.**

Be sure to use only the specified accessory parts. Use of other than designated parts may damage this unit internally or may not securely install the unit in place. This may cause parts to become loose resulting in hazards or product failure.

---

**CONNECT LEADS PROPERLY.**

Be sure to connect the colour coded leads according to the diagram. Incorrect connections may cause the unit to malfunction or cause damage to the vehicle's electrical system.

---

**HALT USE IMMEDIATELY IF A PROBLEM APPEARS.**

Failure to do so may cause personal injury or damage to the product. Return it to your authorized Alpine dealer or the nearest Alpine Service Center for repairing.

---

**EXCEPT FOR THE CAMERA, DO NOT ATTACH ANY PARTS TO AREAS WHICH WILL GET WET, OR WHERE THERE IS A LOT OF HUMIDITY OR DUST.**

Failure to do so may result in fire or damage.

---

**DO NOT ATTACH THE CAMERA TO FLUOROCARBON RESIN FINISHED CAR BODIES OR GLASS.**

Doing so reduces the strength of the camera's mounting. This could cause it to fall off and cause injury or damage to the car's body.

---

**DO NOT ATTACH THE CAMERA TO ANY SURFACE WHERE THE ENTIRE ADHESIVE SURFACE CANNOT BE APPLIED.**

Doing so reduces the strength of the camera's mounting. This could cause it to fall off and cause injury or damage to the car's body.

---

## **NOTICE**

- **About Care of Device**

Do not assert any excess pressure to the camera or the mounting, as this could cause the camera direction to shift, or the camera mounting bracket to come off.

- To prevent the camera lens, mounting and cords from changing colour or shape, or from deteriorating, wipe with a chemical-free, damp cloth.

- Do not use an automatic car wash or high-pressure washer. Doing so could cause the camera to come off, damage to the device cord, or may allow water to enter the camera or the inside of the car.

- In some cases, to attach the device, a hole must be drilled in the car body, requiring use of touch-up paint (retail product) for rust-prevention, and should be prepared beforehand.

- Be sure to disconnect the cable from the (-) battery post before installing your HCE-C500 series. This will reduce any chance of damage to the unit in case of a short-circuit.

- **About Rear Camera**

The rear camera is optimised for use in this system. as a dedicated product, it should not be used in other systems.

- **Do not use mobile phones and wireless devices near the camera.**

Doing so may result in noise on the screen or malfunction. It is recommended to use mobile phones or wireless devices away from the camera.

- **About Camera Installation Location**

Before installing, make sure there is a enough space to be able to install the camera. If possible, install the camera in the center of the bumper. If the camera is installed off-center, the image may differ from the actual view. Calibration is necessary.

- **Confirming the Display Function**

To connect the unit, confirm that the monitor will require a compatible RCA pin jack.

# Feature

## About the TOPVIEW® CAMERA SYSTEM

The TOPVIEW® CAMERA SYSTEM displays the blind area outside the driver's range of vision, using four cameras installed on the front, back, right and left of the vehicle. It is useful for checking for objects around the vehicle. For example, when parking, when navigating narrow roads and "blind" corners, and when reversing.

### Example of Camera Installation

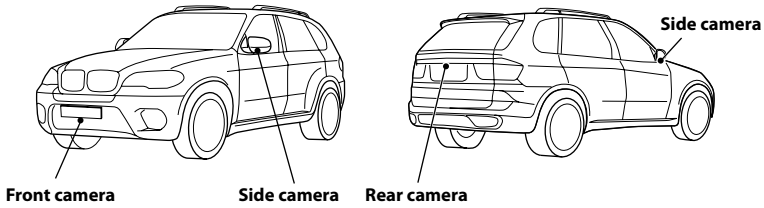

- An installation kit suitable for your vehicle model is required to install this system.  
Performance cannot be assured if you install this system by any other means.

### Example of Camera Image

#### ■ Front View Display Indications

##### <Front Panorama View>

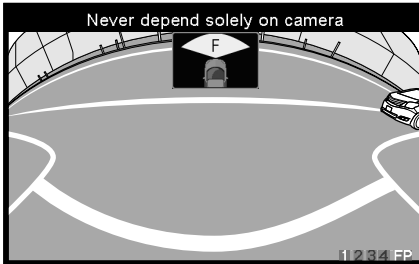

##### <Front Side View>

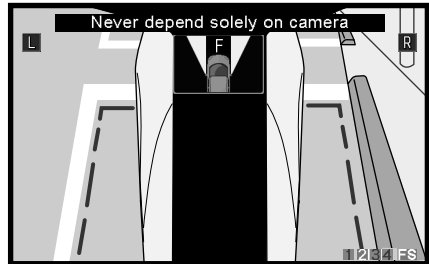

##### <Front Top View>

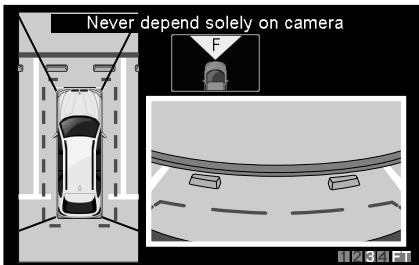

##### <Front Corner View>

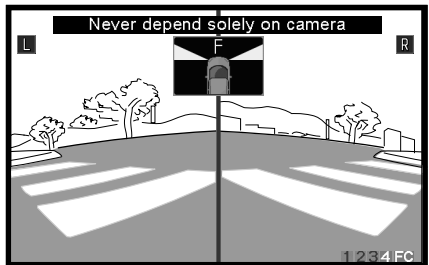

## ■ Rear View Display Indications

### <Rear Panorama View>

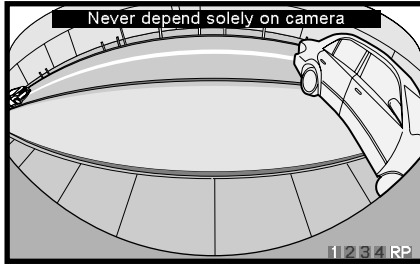

### <Rear Mirror View>

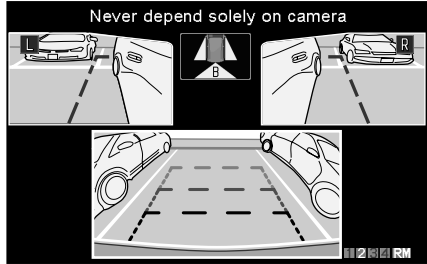

### <Rear Top View>

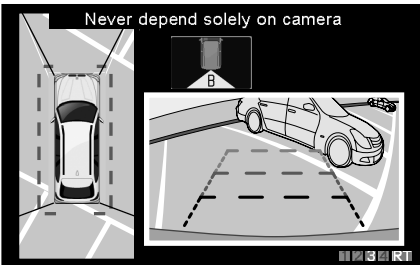

### <Rear View>

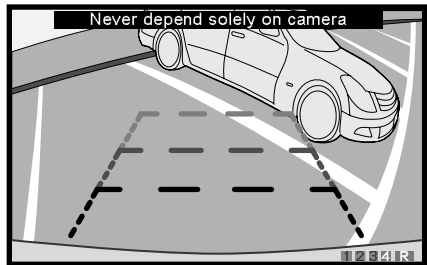

- With this system, the brightness and tint of each camera is automatically adjusted. When driving in areas where the brightness or tint varies widely, the brightness or tint of the camera image on the screen may become unstable.
- Depending on the condition of the car or road surface, the range of vision may vary. Refer to "About the Front Camera Image and Camera Guide" (page 7) or "About the Rear Camera Image and Camera Guide" (page 8).

# Camera Image

## Image Patterns and Distance Guidelines

This camera system synthesises and combines four camera images, enabling you to select and switch to any image pattern. The distance guidelines displayed vary for each pattern. For details of how to switch image patterns, refer to “Camera Operation” (page 14).

### How to Interpret a Camera Image

#### <Front Panorama View>

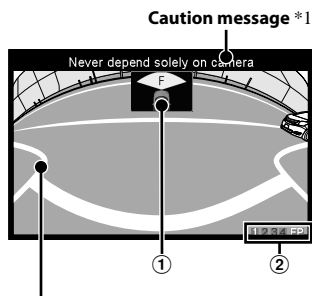

**Camera Image Range**  
\* Varies with image pattern

#### <Rear View>

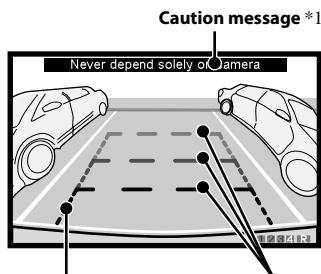

**Vehicle width extension marks**  
\* Only displayed in the rear view image.

**Distance guidelines**  
\* Vary with image pattern

\*1 If no caution message is displayed, be sure to make the correct display settings. Have an authorized Alpine dealer perform the correct display settings in calibration mode.

- ①: Current image range
- ②: Current image pattern

#### <Front View Image>

##### ▶ Front Panorama View



- ② 1 FP  
||| 2 3 4 5 6 7 8 9 10 11 12 13 14 15 16 17 18 19 20 21 22 23 24 25 26 27 28 29 30 31 32 33 34 35 36 37 38 39 40 41 42 43 44 45 46 47 48 49 50 51 52 53 54 55 56 57 58 59 60 61 62 63 64 65 66 67 68 69 70 71 72 73 74 75 76 77 78 79 80 81 82 83 84 85 86 87 88 89 90 91 92 93 94 95 96 97 98 99 100

##### ▶ Front Side View



- ② 2 FS  
||| 2 3 4 5 6 7 8 9 10 11 12 13 14 15 16 17 18 19 20 21 22 23 24 25 26 27 28 29 30 31 32 33 34 35 36 37 38 39 40 41 42 43 44 45 46 47 48 49 50 51 52 53 54 55 56 57 58 59 60 61 62 63 64 65 66 67 68 69 70 71 72 73 74 75 76 77 78 79 80 81 82 83 84 85 86 87 88 89 90 91 92 93 94 95 96 97 98 99 100

##### ▶ Front Top View



- ② 3 FT  
||| 2 3 4 5 6 7 8 9 10 11 12 13 14 15 16 17 18 19 20 21 22 23 24 25 26 27 28 29 30 31 32 33 34 35 36 37 38 39 40 41 42 43 44 45 46 47 48 49 50 51 52 53 54 55 56 57 58 59 60 61 62 63 64 65 66 67 68 69 70 71 72 73 74 75 76 77 78 79 80 81 82 83 84 85 86 87 88 89 90 91 92 93 94 95 96 97 98 99 100

##### ▶ Front Corner View



- ② 4 FC  
||| 2 3 4 5 6 7 8 9 10 11 12 13 14 15 16 17 18 19 20 21 22 23 24 25 26 27 28 29 30 31 32 33 34 35 36 37 38 39 40 41 42 43 44 45 46 47 48 49 50 51 52 53 54 55 56 57 58 59 60 61 62 63 64 65 66 67 68 69 70 71 72 73 74 75 76 77 78 79 80 81 82 83 84 85 86 87 88 89 90 91 92 93 94 95 96 97 98 99 100

#### <Rear View Image>

##### ▶ Rear Panorama View

- ① No icon

- ② 1 RP  
||| 2 3 4 5 6 7 8 9 10 11 12 13 14 15 16 17 18 19 20 21 22 23 24 25 26 27 28 29 30 31 32 33 34 35 36 37 38 39 40 41 42 43 44 45 46 47 48 49 50 51 52 53 54 55 56 57 58 59 60 61 62 63 64 65 66 67 68 69 70 71 72 73 74 75 76 77 78 79 80 81 82 83 84 85 86 87 88 89 90 91 92 93 94 95 96 97 98 99 100

##### ▶ Rear Mirror View



- ② 2 RM  
||| 2 3 4 5 6 7 8 9 10 11 12 13 14 15 16 17 18 19 20 21 22 23 24 25 26 27 28 29 30 31 32 33 34 35 36 37 38 39 40 41 42 43 44 45 46 47 48 49 50 51 52 53 54 55 56 57 58 59 60 61 62 63 64 65 66 67 68 69 70 71 72 73 74 75 76 77 78 79 80 81 82 83 84 85 86 87 88 89 90 91 92 93 94 95 96 97 98 99 100

##### ▶ Rear Top View



- ② 3 RT  
||| 2 3 4 5 6 7 8 9 10 11 12 13 14 15 16 17 18 19 20 21 22 23 24 25 26 27 28 29 30 31 32 33 34 35 36 37 38 39 40 41 42 43 44 45 46 47 48 49 50 51 52 53 54 55 56 57 58 59 60 61 62 63 64 65 66 67 68 69 70 71 72 73 74 75 76 77 78 79 80 81 82 83 84 85 86 87 88 89 90 91 92 93 94 95 96 97 98 99 100

##### ▶ Rear View

- ① No icon

- ② 4 R  
||| 2 3 4 5 6 7 8 9 10 11 12 13 14 15 16 17 18 19 20 21 22 23 24 25 26 27 28 29 30 31 32 33 34 35 36 37 38 39 40 41 42 43 44 45 46 47 48 49 50 51 52 53 54 55 56 57 58 59 60 61 62 63 64 65 66 67 68 69 70 71 72 73 74 75 76 77 78 79 80 81 82 83 84 85 86 87 88 89 90 91 92 93 94 95 96 97 98 99 100



## About the Front Camera Image and Camera Guide

### ■ Front Panorama View

Displays a wider-angled perspective of the area in front of the vehicle.

Use this when you want to make a wide-sweeping check in front of the vehicle. For example, when emerging from a narrow street onto a main road where the oncoming traffic is hard to see.

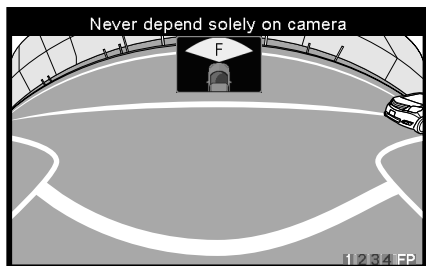

\* Distance guidelines are not displayed.

### ■ Front Side View

The split-screen image displays the area on each side in front of the vehicle.

Use this when you want to check the area ahead on each side. For example, when pulling onto a hard shoulder or pulling over to a kerb.

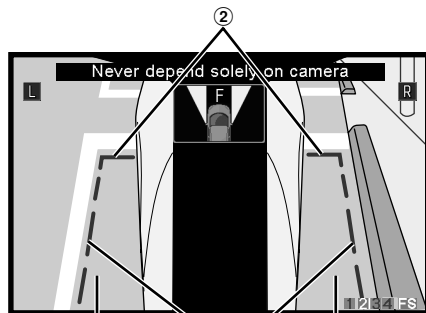

Left Side View

Right Side View

#### ► Indication mark meaning

- ① Guidelines representing a distance of approx. 0.5 m on each side of the vehicle.
- ② Guidelines representing a distance of approx. 0.5 m in front of the vehicle.

### ■ Front Top View

The split-screen image displays an all-round view from above the vehicle and the front view.

Use this when you want to check for objects around or in front of the vehicle. For example, when parking the vehicle in a garage.

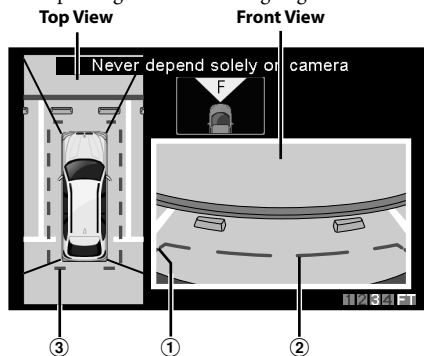

#### ► Indication mark meaning

- ① Guidelines representing a distance of approx. 0.5 m on each side of the vehicle.
- ② Guidelines representing a distance of approx. 0.5 m in front of the vehicle.
- ③ Guidelines representing a distance of approx. 0.5 m all round the vehicle.

- Top View synthesises images from 4 cameras and displays the combined view on the monitor. As the sensitivity of each camera is individually adjusted to the optimal degree, the image on the monitor may appear rather unnatural (brightness, tint, etc.).

### ■ Front Corner View

Displays a divided image left and right of centre.

Use this mainly when checking the left and right directional view.

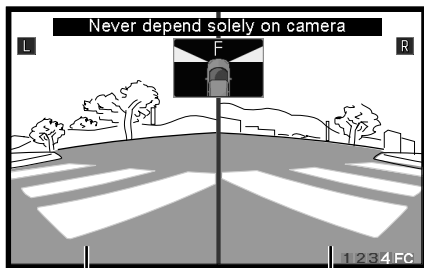

Left Side Corner View

Right Side Corner View

\* Distance guidelines are not displayed.

- With Top View, the camera image around the joins or borders may not be displayed. For details, refer to “About Top View Blind Spots” (page 13).
- Do not use Top View while retracting the door mirrors or when the vehicle doors are not completely closed, as the image will not be displayed properly.
- For details of how to switch image patterns, refer to “Camera Operation” (page 14).
- In the following conditions, screen visibility may be impaired. This is not a malfunction.
  - When it is dark (at night, etc.).
  - When the temperature around the camera lens is high or low.
  - When water drops adhere to the camera, or when the humidity is high (such as rainy weather, etc.).
  - When foreign bodies (such as mud, etc.) adhere to the camera or its peripheral area.
  - When sunlight or headlights directly strike the camera lens.
- The image range will be affected by the height or inclination of the vehicle. The position indicated by the distance guidelines, actual distance from the road surface and distances from objects will vary, depending on factors such as number of passengers, load weight and suspension adjustments. In addition, joins in Top View images may not be properly aligned. Always visually check the actual conditions around the vehicle to ensure safety.

## About the Rear Camera Image and Camera Guide

### ■ Rear Panorama View

Displays a wider-angled perspective of the area behind the vehicle.

Use this when you want to make a wide-sweeping check behind the vehicle. For example, when you are reversing out of a narrow street onto a main road where the oncoming traffic is hard to see.

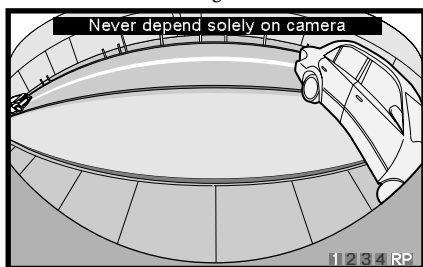

\* Distance guidelines are not displayed.

### ■ Rear Mirror View

The triple-screen image displays the area on each side behind the vehicle.

Use this when you want to check the area on each side behind the vehicle. For example, when reversing into a garage, reversing onto a hard shoulder or pulling over to a kerb in reverse.

Left Mirror View

Right Mirror View

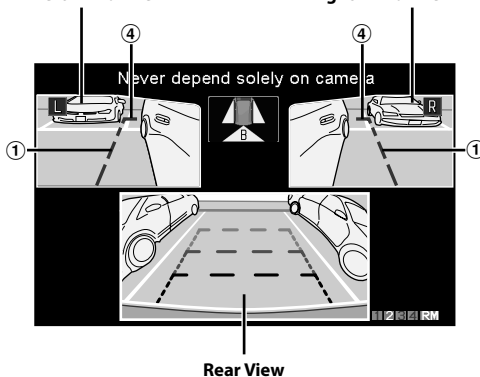

#### ► Indication mark meaning

- ① Guidelines representing a distance of approx. 0.5 m on each side of the vehicle.
- ④ Guidelines representing a distance of approx. 0.5 m behind the vehicle.

- Rear View: Refer to “Rear View” (page 9).

### ■ Rear Top View

The split-screen image displays an all-round view from above the vehicle and the rear view.

Use this when you want to check for objects around or behind the vehicle. For example, when reversing into a garage.

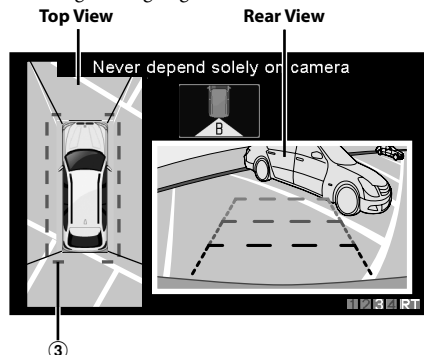

► **Indication mark meaning**

③ **Guidelines representing a distance of approx. 0.5 m all round the vehicle.**

- **Rear View:** Refer to “Rear View” (page 9).
- **Top View** synthesises images from four cameras and displays the combined view on the monitor. As the sensitivity of each camera is individually adjusted to the optimal degree, the image on the monitor may appear rather unnatural (brightness, tint, etc.).
- *With Top View, the camera image around the joins or borders may not be displayed. For details, refer to “About Top View Blind Spots” (page 13).*
- *Do not use Top View while retracting the door mirrors or when the vehicle doors are not completely closed, as the image will not be displayed properly.*
- *For details of how to switch image patterns, refer to “Camera Operation” (page 14).*
- *The rear camera image is a mirror image. The image in the display is reversed, as you would see through the rearview mirror. As the camera uses a wide-angle lens, there is a difference between the actual distance and what appears on the screen.*
- *Images may not be clearly displayed in the following conditions. This is normal.*
  - *In the dark (nighttime, etc.)*
  - *The temperature near the lens is high or low.*
  - *The camera has water droplets on it or the humidity is high (rainy day, etc.).*
  - *Foreign substances (dirt, etc.) are on or around the camera.*
  - *Sun light or the light of a headlamp directly enters the camera lens.*
- *The image range will be affected by the height or inclination of the vehicle. The position indicated by the distance guidelines, actual distance from the road surface and distances from objects will vary, depending on factors such as number of passengers, load weight and suspension adjustments. In addition, joins in Top View images may not be properly aligned. Always visually check the actual conditions around the vehicle to ensure safety.*

■ **Rear View**

Displays the area behind the vehicle. Use this when reversing into a garage or when checking for objects behind the vehicle.

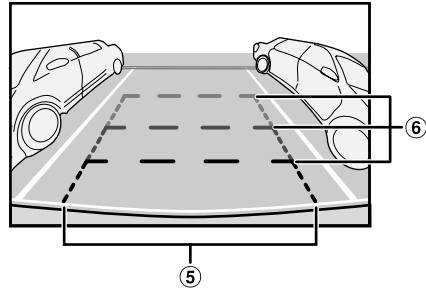

► **Indication mark meaning**

⑤ **Car width extension marks (orange, yellow and green in order of distance)**

If properly calibrated, the marks indicate the car's width. This helps guide the car's path when backing up in a straight line.

⑥ **Distance guidelines**

The horizontal lines represent the distance from the rear of the car (from the rear end of the bumper).

- The lines do not move in synchronisation with the steering wheel.
- Each line represents a distance of 0.5 m (orange), 1 m (yellow) and 2 m (green) behind the vehicle.
- *Depending on the condition of the car or road surface, the range of vision may vary.*
- *The camera has a limited range of vision. Objects at extreme angles to the camera (e.g. under the bumper or at opposite ends of the bumper) may not be in its field-of-vision.*
- *The rear camera image may have a tint which is different from the actual surroundings.*
- *Depending on the car, the guidance may deviate to the right or left. This is not a malfunction.*

## Distance guidelines

The distance guides represent the ground level distance from the rear bumper. It is difficult to accurately estimate the distance to objects above ground level.

<Screen>

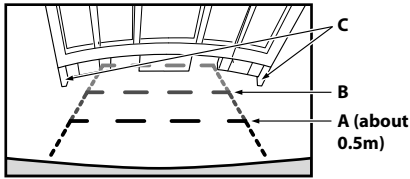

<Positions of A, B and C>  
about 1m

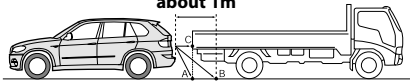

In the screen, according to the distance guidelines, the truck seems to be parked about 1 m away (at the position B). In actual fact, however, if you reversed to position A, you would collide with the truck. In the screen, positions A, B and C seem to be located in order of proximity. However, in actual fact, the position A and C are the same distance, and B is farther away than positions A and C.

- The car width extension mark represents the distance to the road surface. The distance to an object on the road is not accurately represented by the guides.
- In the following conditions, screen visibility may be impaired. This is not a malfunction.
  - When it is dark (at night, etc.).
  - Under very high or very low temperature conditions.
  - When water drops adhere to the camera, or when the humidity is high (such as rainy weather, etc.).
  - When foreign bodies (such as mud, etc.) adhere to the camera or its peripheral area.
  - When sunlight or headlights directly strike the camera lens.

## Error Between the Display and Actual Road Surface

Under the following conditions, errors are produced between the display guidelines and the actual road surface. (The illustrations represent a case when the camera is installed in the standard position.)

### ■ When there is a steep upward slope behind the car (example)

<Screen>

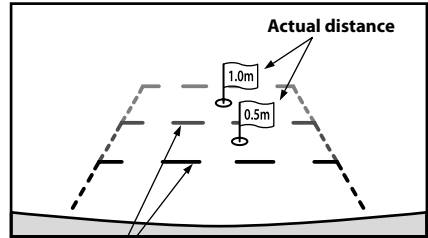

Distance guidelines

<Situation of the car>

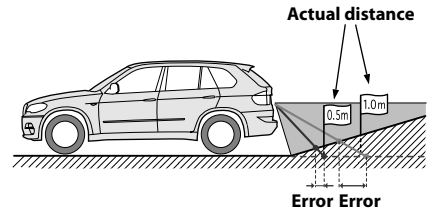

The distance guidelines represents the distance to a flat road surface. Therefore in the case of an upward slope behind the car, the distance guides are displayed closer to the rear bumper than the actual distance. For example, if there is an obstacle on the upward slope, it may appear farther away than its actual position. Also, an error may occur between the guidance and the actual path of the car on the road surface.

## ■ When there is a steep downward slope behind the car (example)

<Screen>

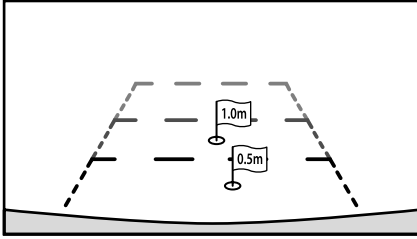

<Situation of the car>

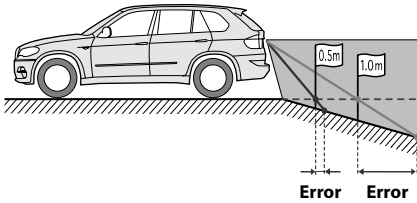

In the case of a downward slope behind the car, the distance guides are displayed farther from the rear bumper than the actual distance.

If there is an obstacle on the downward slope, it seems closer than its actual position. Also, an error may occur between the guidance and the actual path of the car on the road surface.

---

## About Calibration

---

- Before using this camera system, calibration is required to set the vehicle width and guidelines for the specific vehicle model. A special measuring kit is needed and the system can only be calibrated by an authorised ALPINE dealer. For details, contact your ALPINE dealer.
- If the height of the vehicle is changed due to any of the following situations, the settings must be reconfigured. Please contact your ALPINE dealer.
  - If you have changed from summer tyres to winter tyres
  - If you have changed the wheel size
  - If you have adjusted the suspension



### CAUTION

- Any changes to the height of the vehicle will alter the blind spot in the Top View camera images. For details, refer to “About Top View Blind Spots” (page 13).

---

## About the Image Range

---

This camera system uses four cameras installed on the front and rear of the vehicle and on the door mirrors, to display the surrounding area. However, blind spots exist that are not displayed by the cameras.

Do not under any circumstances drive depending solely on the view on the screen. Always perform a visual check as well as looking in the rearview mirror and door mirrors, and ensure that it is safe in front, behind and around the vehicle.

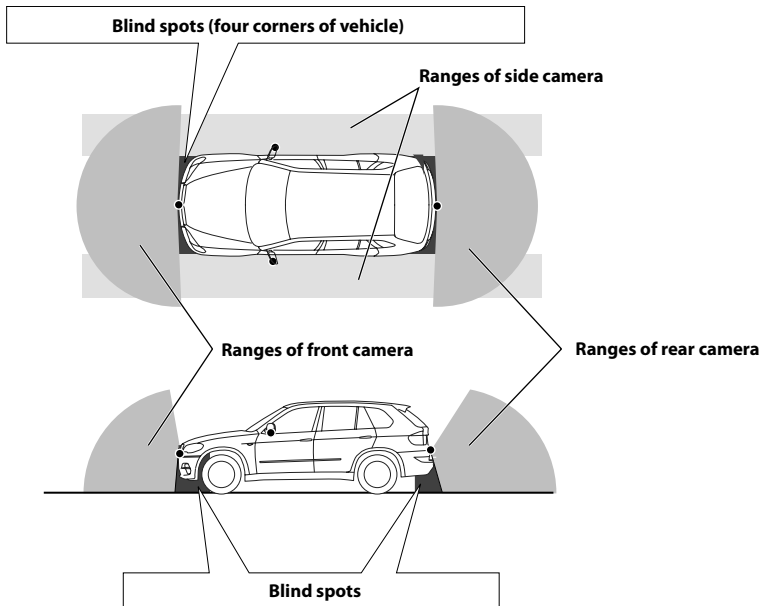

## ■ About Top View Blind Spots

Top View synthesises and combines images from the front, rear and side cameras and displays the view on the screen. The area outside the cameras' range and around the cameras' borders is not displayed. Do not under any circumstances drive depending solely on the view on the screen. Always perform a visual check as well as looking in the rearview mirror and door mirrors, and ensure that it is safe in front, behind and around the vehicle.

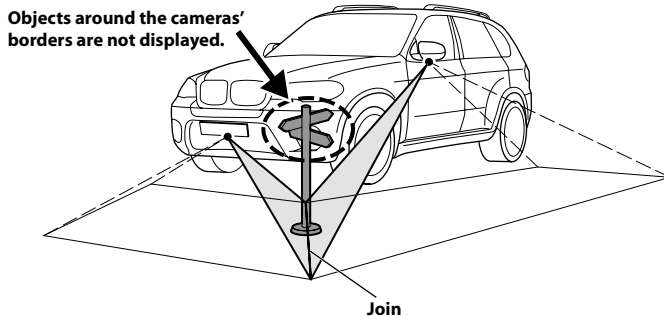

### CAUTION

- With Top View, a blind zone exists where the camera images meet. The calibration settings will have been configured by your ALPINE dealer to minimise this blind zone, but if you change the height of the vehicle after purchasing the camera system (after the system has been calibrated), the following changes to the blind zone may occur.
  - If you lower the height of the vehicle: the blind zone will increase.
  - If you raise the height of the vehicle: the same object may also appear in adjacent camera images.
- For details, contact your ALPINE dealer.

## Camera Operation

This camera system enables you to perform the following operations in the camera view, using the iDrive Controller.

### ■ iDrive Controller Operation

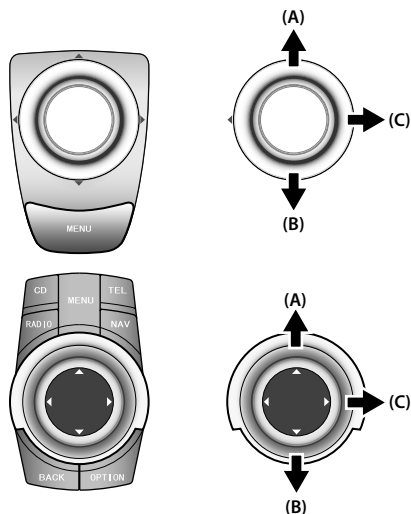

**(A) The display switches between the front view image and rear view image.**

**(B) The display switches the Image Patterns.**  
For details, refer to "Switching Image Patterns" (page14).

**(C) The display switches the Screen Format.**  
[4:3] → [5:4] → [16:9] → [21:9] → [16:9 (left screen display)] → [4:4 (right screen display)] → [4:3] ...

- Some images may not be displayed, depending on camera image display method. For details, refer to "Displaying the Camera Image."

## Displaying the Camera Image

### Displaying the Camera Image by Pressing the PDC button

Availability of this function depends on the factory configuration of the vehicle.

### ■ Centre console



PDC button

### 1 Press the PDC button.

The front or rear view image previously displayed is displayed again.

- The iDrive Controller enables you to perform the following operations.

**(A) The display switches between the front view image and rear view image.**

**(B) The display switches the Image Patterns.**

**(C) The display switches the Screen Format.**

- If you shift the gear lever to the reverse (R) position while the front view image is displayed, the rear view image will be displayed.

### 2 To turn hide the camera image, press the PDC button again.

The front view image previously displayed is displayed again.



## Displaying the Camera Image using the iDrive Controller

### ■ iDrive Controller

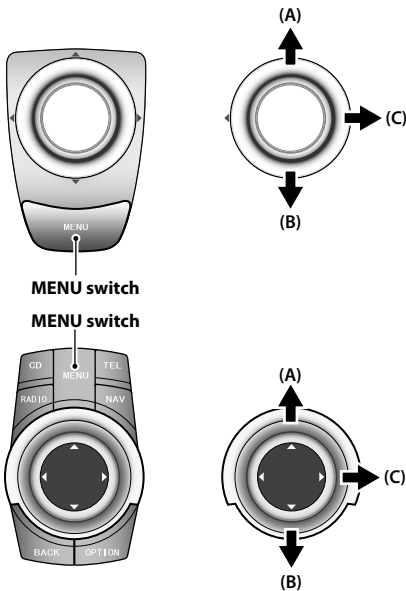

#### 1 Press and hold the MENU switch.

The front or rear view image previously displayed is displayed again.

- The iDrive Controller enables you to perform the following operations.

(A) The display switches between the front view image and rear view image.

(B) The display switches the Image Patterns (Front view only)

\* To switch image pattern while the Rear view image is displayed, set the gear lever to the reverse (R) position.

(C) The display switches the Screen Format.

- If you shift the gear lever to the reverse (R) position while the front view image is displayed, the rear view image will be displayed.

#### 2 To hide the camera image, press the MENU switch once more.

## Displaying the rear view image while the car is in reverse

Displaying the rear image by shifting the gear lever.

#### 1 Shift the gear lever to the reverse (R) position.

The rear view image is displayed while the car remains in reverse.

#### 2 If you shift the gear lever to a position other than reverse (R), the monitor will return to the previous screen.

- The iDrive Controller enables you to perform the following operations.

(B) The display switches the Image Pattern.

(C) The display switches the Screen Format.

## Switching Image Patterns

The image pattern switches with operation (B) of the iDrive Controller.

For details of the image patterns, refer to “Camera Image” (page 6).

### <Front view>

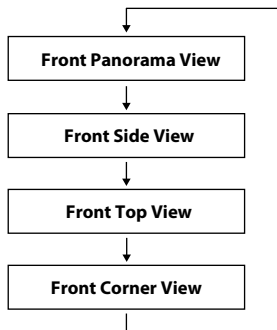

### <Rear view>

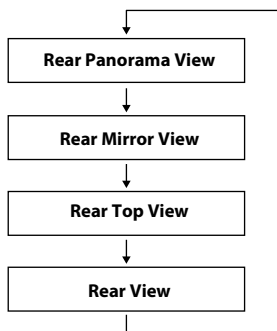

# Installation and Connections

- Be sure to disconnect the cable from the (-) battery post before installing your HCE-C500 series. This will reduce any chance of damage to the unit in case of a short circuit.
- Be sure to connect the colour coded leads according to the diagram. Incorrect connections may cause the unit to malfunction or damage to the vehicle's electrical system.
- When making connections to the vehicle's electrical system, be aware of the factory installed components (e.g. on-board computer). Do not tap into these leads to provide power for this unit. When connecting the HCE-C500 series to the fuse box, make sure the fuse for the intended circuit of the HCE-C500 series has the appropriate amperage. Failure to do so may result in damage to the unit and/or the vehicle. When in doubt, consult your Alpine dealer.
- Route the cables and wiring away from hot or moving parts, and fix them securely to avoid heat/mechanical damage to the cable insulation, which may result in short-circuit, fire or electric shock.
- When fixing the control unit, camera, and alarm to the vehicle with screws, attaching to weak spots may damage vehicle parts.
- If the camera is not mounted securely, shifting positions will cause deterioration of detection performance.
- The cable may break due to stress caused when opening and closing the door/trunk of the vehicle.
- If the control unit becomes wet, the electrical circuitry may short out.
- The camera is designed specifically for use with this system. The system cannot be used with a different camera.
- This product cannot be installed in or used with anything other than a car (in other words, it cannot be used with motorcycles, mobility vehicles, or electric wheelchairs or as a household security camera, etc.).

## CAUTION

- An installation kit suitable for your vehicle model is required to install this system. Performance cannot be assured if you install this system by any other means. Be sure to check your type of vehicle before installing the system.
- Professional expertise and experience are required to install this camera system. For details of how to install and connect the cameras, refer to the installation manual for the vehicle installation kit (sold separately). A special measuring kit is needed and the system can only be calibrated by an authorised ALPINE dealer. For details, contact your ALPINE dealer.

## Check Accessory Parts

Camera



Front camera x1  
Rear camera x1  
Side camera (L) x1  
Side camera (R) x1

Control unit

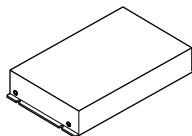

Power cable

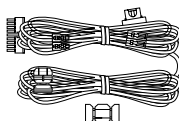

(Solderless connector)

Camera cable  
(for side camera)



(Including video output)

Camera cable  
(for front/rear camera)



Camera junction cable  
(for side camera)

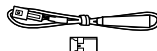

(x2 sets)

Front camera extension cable  
(5.5m)



Rear camera extension cable  
(8m)



Side camera (L) extension  
cable (3.5m)



Side camera (R) extension  
cable (3.5m)



Velcro fastener (Control unit)

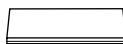

Self-Tapping screw  
(Control unit)



(x4)

Wire clamp (large)



(x10)

Wire clamp (small)



(x15)

# Connections

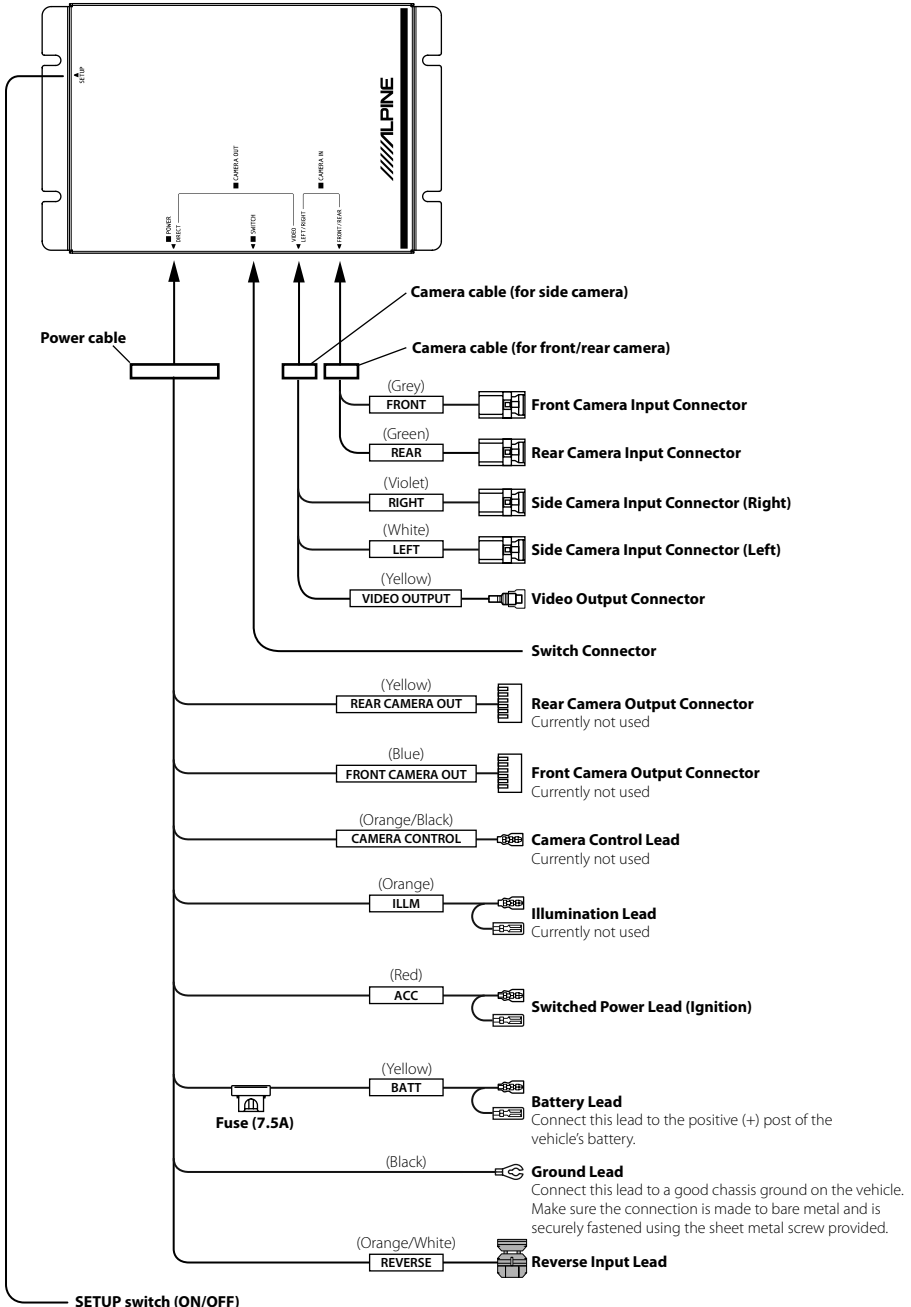

# System Example

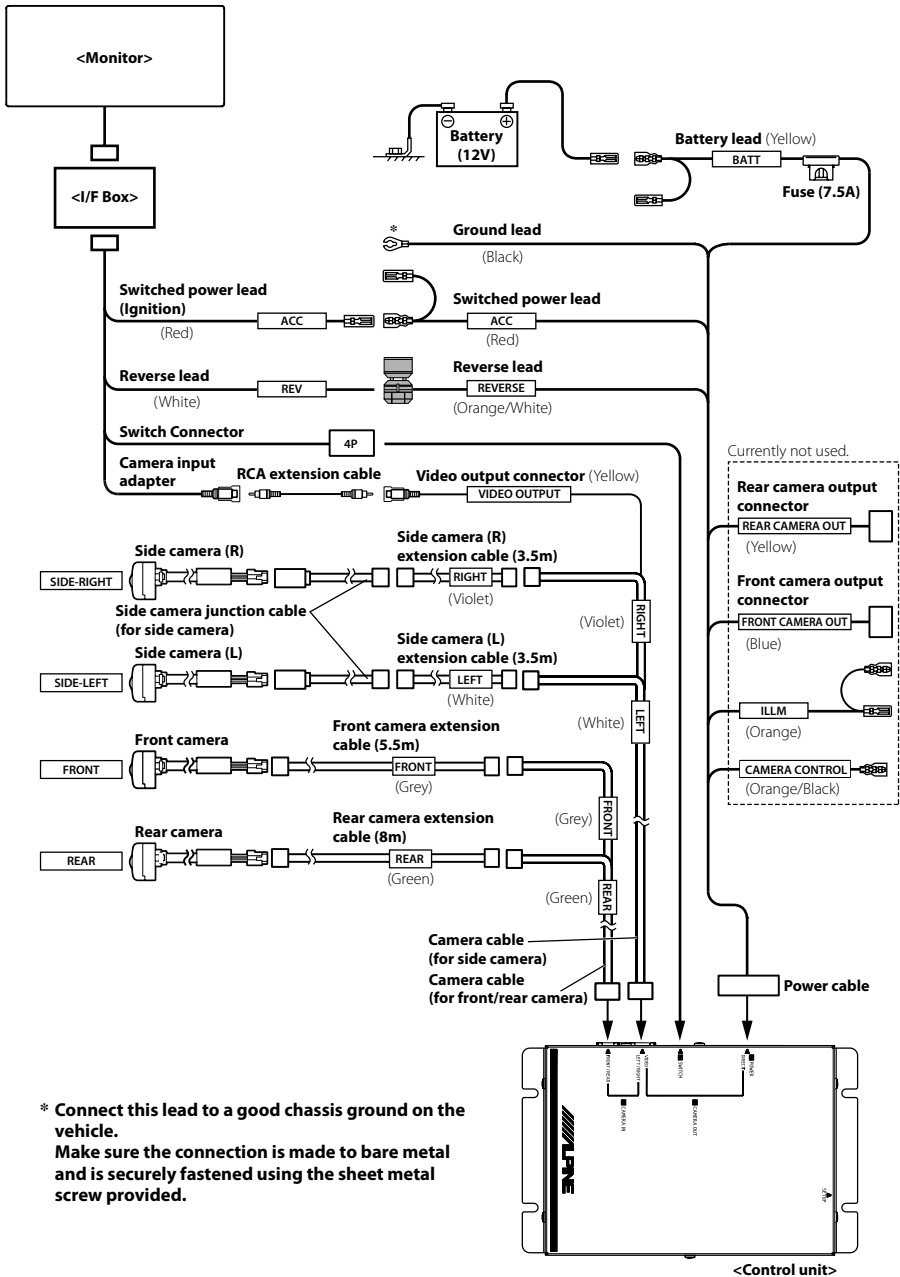

# Information

## Specifications

### ■ Camera section

Image sensor .....	1/3.8 Type CMOS Image sensor, aspect ratio 4 : 3
Effective Number of Pixels ..	1296 (horizontal) × 985 (vertical) approximately 1.28 Megapixels
Lens Section .....	Focal length $f = 0.89$ mm, brightness $F = 2.8$
Angle of Field .....	Horizontal: $186^\circ$ , Vertical: $144^\circ$
Automatic Image Adjusting Function .....	Automatic metering adjustment, Automatic white balance adjustment
Synchro-System .....	Internal synchronisation
Luminance S/N .....	40dB or more
Resolution (Horizontal) .....	300 TV lines (center area)
Illumination Range .....	2 to 100,000 lx
Operating Temperature Range .....	-22 to +176 °F (-30 to +80 °C)
Storage Temperature Range .....	-40 to +185 °F (-40 to +85 °C)
External Dimensions .....	23.4 × 23.4 × 21.3mm (excluding cable)
Weight .....	30 g (including cable)

### ■ Control unit section

Power Requirements .....	14.4 V DC (11 to 16 V allowable)
Ground Type .....	Negative ground type
Output Image .....	CVBS (NTSC Colour signal system)
Output Drive Capacity .....	75 ohm (W)
Operating Temperature Range .....	-4 to +140 °F (-20 to +60 °C)
External Dimensions .....	176 × 110 × 30 mm (W × D × H)
Weight .....	450 g (including cable)

## In Case of Difficulty

- The camera image does not appear. (Images other than that of the camera are normal.)

Cause	Solution
The ignition key is set to a position other than ON.	Set the ignition key to ON.
No fuse is installed, or there is a break in the connection.	Install a fuse, or replace a relevant fuse after checking the cause.
The connection is not correctly established.	Check whether the connection is correctly established while referring to this owner's manual.
The reverse signal line of the connected product is not connected.	Connect the reverse signal line while referring to the owner's manual of the connected product.
The video connection cable is not connected to the camera input of the connected product.	Connect the video connection cable to the camera input while referring to the owner's manual of the connected product.

- The camera image is not normal. (Images other than that of the camera are normal.)

Symptom	Cause/Solution
The display screen flickers.	If a place illuminated by a fluorescent lamp is captured, the display screen may flicker. This is not a failure.
The screen is difficult to read.	If a dark place or a partially bright light is captured, or if the temperature of the main body of the camera is high, the screen may be difficult to read. This is not a malfunction.
The camera image sways.	Check the installation status, and check screws for looseness.
The camera image is unclear.	If the camera lens is dirty, wipe the lens softly with a soft cloth moistened with water.

• Others

<b>Symptom</b>	<b>Cause/Solution</b>
There are noises on the radio.	If there are noises on the radio, keep the camera cables and the video cables away from the wire harness, the radio antenna, and the antenna cables of the vehicle.

If there is a serious symptom, for example, the distance guidance marks deviates significantly from the actual distance, stop using this system and contact your ALPINE dealer.

